

# COMPOSITION SHINGLE L-FOOT INSTALL KIT WITH INVISIMOUNT™ RAIL BOLT

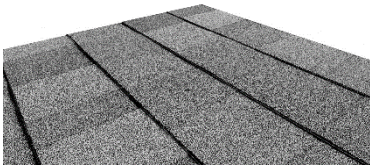

**Pegasus Solar's Composition Shingle L-Foot Install Kit is a cost effective, high-quality option for Invisimount™ rail installations in one box. Flashing, L-Foot, Lag Screw with Captured EPDM Washer and M10 nut and bolt are included in a single kit of 24 complete mounts.**

- Industry's first one-piece flashing
- No welds or deck level EPDM washers integrated in the flashing that can fail
- Industry leading 0.9" raised water seal
- Rugged cast constructed L-Foot
- Superior aesthetics with black finish on L-foot, flashing and M10 hardware
- Includes 5/16" SS lag screw with captured EPDM washer and black anodized M10 nut and bolt
- 1.5" of vertical adjustability with L-Foot hardware channel
- Included black M10 hardware for use with SunPower's Invisimount™ system



1. Drill pilot hole in center of rafter.

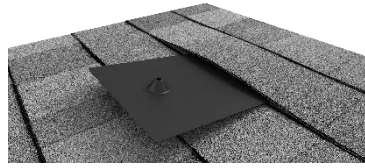

2. Apply a "U-shape" of sealant to underside of flashing and position under 2nd shingle course, cone over pilot hole. Optional: Fill cone with sealant.

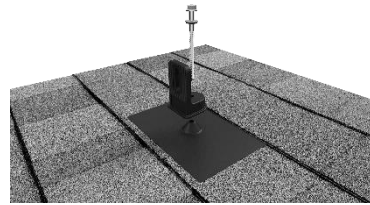

3. Place L-Foot over cone and thread lag with washer through L-Foot.

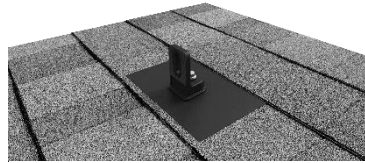

4. Drive lag to required embedment. Attach rail using included M10 nut and bolt per rail manufacturer's instructions.

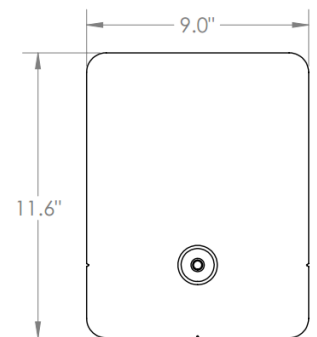
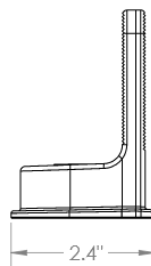
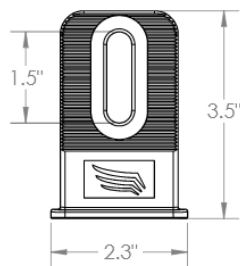

Specifications	Comp. M10 L-Foot Install Kit
Contents	Flashing, L-Foot, Lag, Rail Bolt
Roof Type	Composition Shingle
Certifications	IBC, ASCE/SEI 7-10
Install Application	Railed Systems
Compatible Rail	SunPower Invisimount™
Lag Screw Hardware	5/16" SS w/ washer
Rail Attachment Hardware	M10 nut and Bolt
Flashing Material	Painted Galvalume Plus
L-Foot Material	Cast Aluminum
Kit Quantity	24
Boxes Per Pallet	48
SKU	RRCLC00MIBDK-24

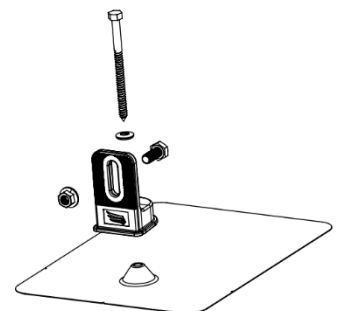

Patents Pending. All rights reserved.  
© 2018 Pegasus Solar Inc.